



AN2432 Application note

EVALSTSR30-60W: 60W AC-DC Adapter with synchronous rectification using L6668 and STSR30

Introduction

This document describes a 60W adapter application using the L6668 fixed frequency current mode PWM controller and the STSR30 smart driver for flyback synchronous rectification.

This chipset guarantees low no-load consumption and high efficiency, making it easy to comply with world-wide mandatory and voluntary energy saving requirements.

EVALSTSR30-60W demo board

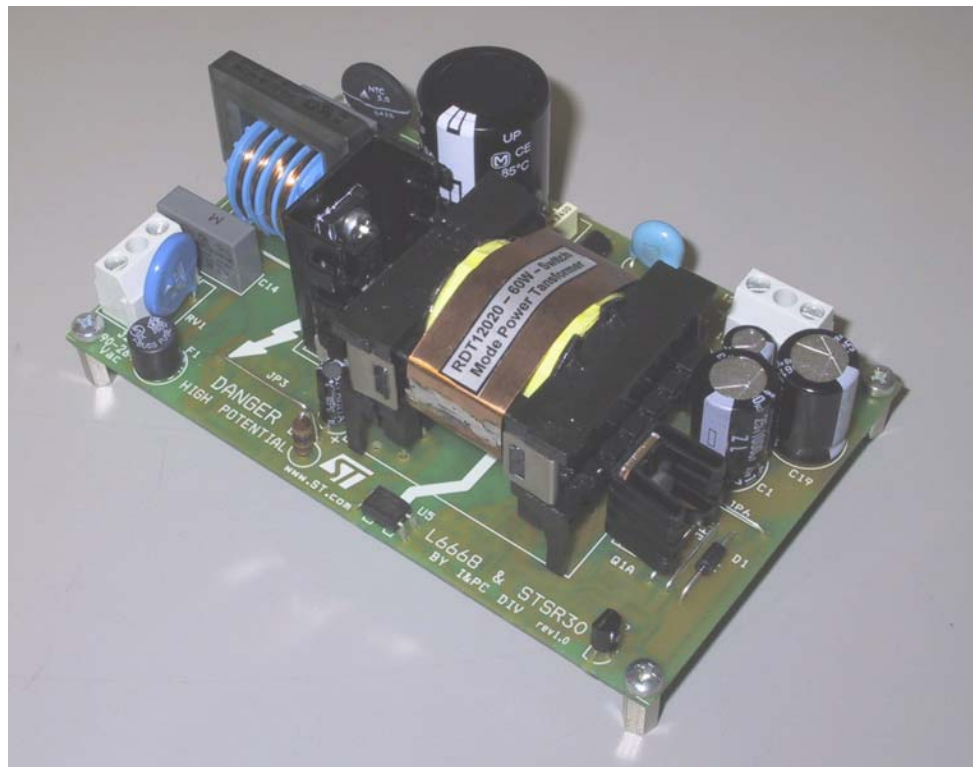

Contents

1	Adapter features	5
1.1	Main characteristics	5
1.2	Circuit description	5
2	Electrical performance	10
3	Functional check	13
3.1	Start-up behavior at full load	13
3.2	Wake-up time	13
3.3	Power-down	14
3.4	Short-circuit tests	15
3.5	Overvoltage protection	15
4	Conducted noise measurements (pre-compliance test)	17
5	Thermal measurements	18
6	Bill of materials	20
7	PCB layout	23
8	Transformer specification	24
8.1	Electrical characteristics	24
8.2	Mechanical aspect	25
9	Revision history	26

List of figures

Figure 1.	Electrical diagram	6
Figure 2.	VIN = 115VRMS - 60Hz	8
Figure 3.	VIN = 230VRMS - 50Hz	8
Figure 4.	VIN = 115VRMS - 60Hz	8
Figure 5.	VIN = 230VRMS - 50Hz	8
Figure 6.	VIN = 115VAC - CCM	9
Figure 7.	CCM - Anticipation detail	9
Figure 8.	VIN = 230VAC - DCM	9
Figure 9.	DCM - INHIBIT synchronization	9
Figure 10.	Burst mode operation at 230VAC and no load	11
Figure 11.	Start-up at 88VAC - 60Hz	13
Figure 12.	Start-up at 264VAC - 50Hz	13
Figure 13.	Wake-up at 115VAC - 60Hz	14
Figure 14.	Wake-up at 230VAC - 50Hz	14
Figure 15.	Power-down at 115VAC - 60Hz	14
Figure 16.	Power-down at 230VAC - 50Hz	14
Figure 17.	Short circuit at 88VAC - 60Hz	15
Figure 18.	Short circuit at 264VAC - 50Hz	15
Figure 19.	OVP at 115VAC - full load	16
Figure 20.	OVP at 230VAC - full load	16
Figure 21.	OVP at 115VAC - no load	16
Figure 22.	OVP at 230VAC - no load	16
Figure 23.	CE peak measure at 115VAC and full load	17
Figure 24.	CE peak measure at 230VAC and full load	17
Figure 25.	VIN = 115VAC - full load	18
Figure 26.	VIN = 230VAC - full load	19
Figure 27.	Silk screen - top side	23
Figure 28.	Silk screen - bottom side	23
Figure 29.	Copper tracks	23
Figure 30.	Transformer electrical diagram	24
Figure 31.	Windings position	25

List of tables

Table 1.	Line and load regulation	10
Table 2.	Efficiency at 115VRMS	10
Table 3.	Efficiency at 230VRMS	10
Table 4.	No load consumption	11
Table 5.	Power consumption with 0.5W output	11
Table 6.	Mandatory energy saving requirements (from 1 January 2008)	12
Table 7.	Voluntary energy saving requirements (from 1 January 2008)	12
Table 8.	Comparison between standard and SR flyback	12
Table 9.	Key components temperature at 115VAC - full load	18
Table 10.	Key components temperature at 230VAC - full load	19
Table 11.	Part list	20
Table 12.	Winding characteristics	25
Table 13.	Revision history	26

1 Adapter features

1.1 Main characteristics

The 60W AC-DC adapter board described in this application note has the following main characteristics:

- Input:
 - V_{IN} : 88 ~ 264 V_{RMS}
 - f: 45 ~ 66 Hz
- Output:
 - 12V_{DC} ± 2% - 5A
- No - Load:
 - Pin below 0.3W
- Short circuit: protected with Auto-Restart feature
- PCB type and size:
 - FR4
 - Single side: 70 μm
 - 120 x 75 mm
- Safety: according to EN60065
- EMI: Compliance with EN55022 - Class B specifications

1.2 Circuit description

This circuit implements a flyback transformer which is a very popular topology for this kind of application and power level, thanks to its simplicity and good trade-off between cost and performance. To improve the converter's efficiency, the EVALSTSR30 demo board uses synchronous rectification.

The converter works in both Continuous and Discontinuous conduction mode depending on the input voltage (the circuit has a wide input voltage range) and the output load. The 68-kHz switching frequency provides a good compromise between the transformer size and the harmonics of the switching frequency, optimizing input filter.

The input section includes protection elements (varistor, fuse and NTC for inrush current limiting), a standard Pi-filter for EMC suppression, a bridge and an electrolytic bulk capacitor as the front-end AC-DC converter. The transformer is a layer type, uses a standard ETD34 ferrite core and is designed to have a reflected voltage of 95V. The power MOS is a 700V - 1Ω and a transil clamp network is used for leakage inductance demagnetization.

On the primary side, the ST L6668 PWM controller integrates all the functions needed in a SMPS (switch mode power supply) and enables building a complete system with a low amount of external components. It includes a high voltage start-up generator, an overvoltage protection input, frequency foldback for better efficiency at light loads, programmable burst mode operation and soft start circuit.

Figure 1. Electrical diagram

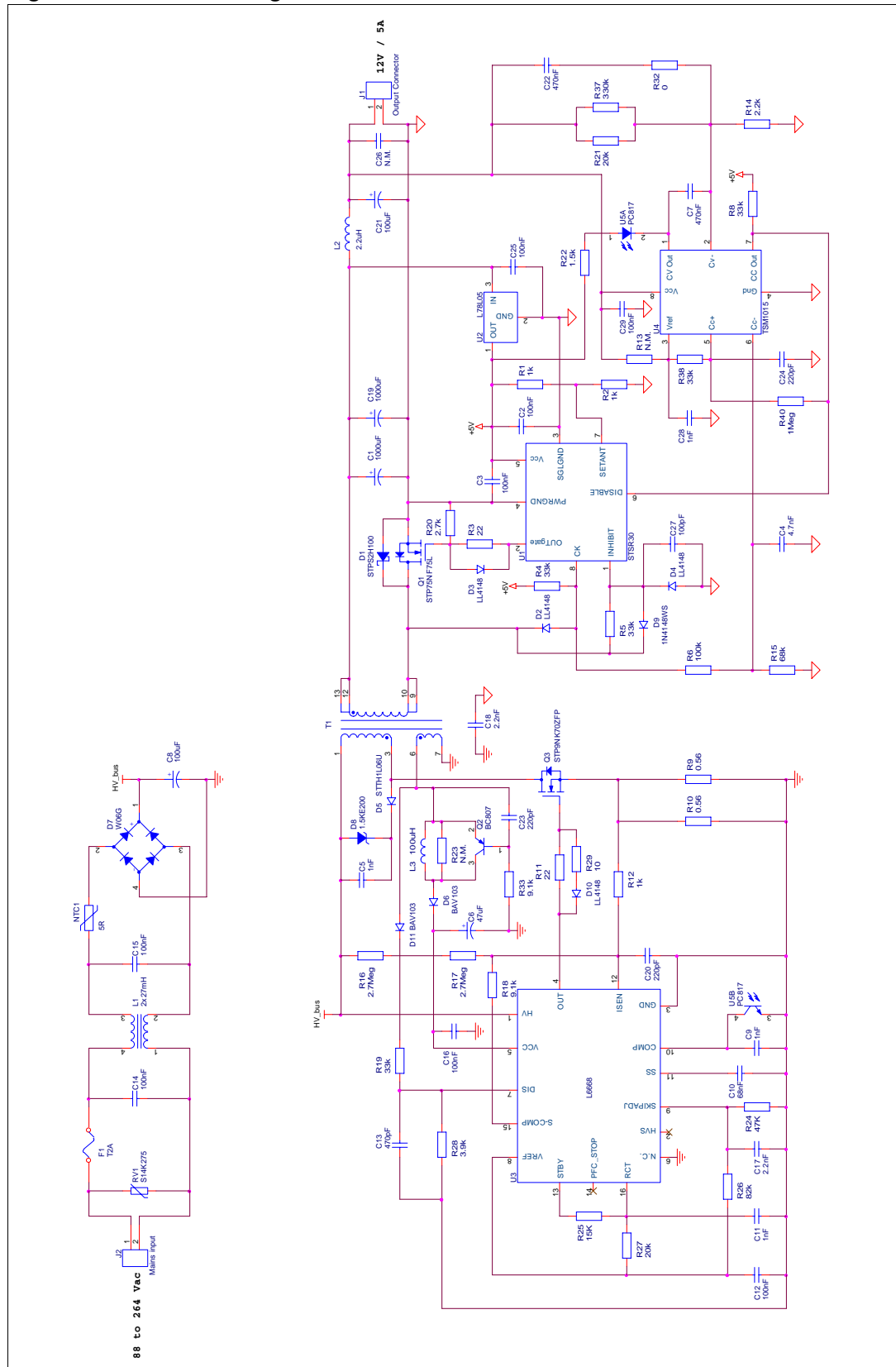

The self supply circuit (Q2, R33, C23, L3, D6 and C6) ensures:

- a constant V_{CC} voltage with respect to load variations
- enough energy during no-load periods
- a poor (under UVLO) supply voltage during short-circuit failures

A separate rectifying circuit (D11, R19, R28 and C13) derives a voltage level that best matches the output voltage for accurate overvoltage protection.

As seen, the primary side is quite standard. The most interesting part of this demo board lies in the secondary side. Here we can find the STSR30, a smart driver for flyback synchronous rectification (SR). The flyback output diode is substituted with a power MOSFET (a 75V - 10m Ω) that dramatically reduces the conduction losses. A small Schottky diode (D1) is mounted in parallel to the MOSFET body diode to keep low the voltage drop during dead times (while the SR MOS is off and current is circulating in the secondary).

The STSR30 can work in both Continuous and Discontinuous conduction mode and uses 2 pins to synchronize the SR MOSFET with the flyback. The SR MOSFET drain provides the synchronization information; when the primary side MOSFET is turned off, the drain voltage of the SR MOSFET falls from $V_{OUT} + V_{IN}/n$ (where n is the transformer turns ratio $n1/n2$) down to zero. This falling edge is sensed by the CK pin and the IC turns on the SR MOSFET. Behavior varies according to the flyback transformer operating mode:

- Continuous conduction mode (CCM): the STSR30 uses an internal digital counter to predict when it has to turn off the SR MOSFET.
- Discontinuous conduction mode (DCM): the STSR30 senses the voltage on the INHIBIT pin (that is, $R_{dson} \times I_{sec}$) and turns off the SR MOSFET when it reaches the -25mV threshold (i.e. the current is approaching zero).

During CCM operation, a certain amount of anticipation is used to prevent cross-conduction of Q3 and Q1. This anticipation can be selected among three values by biasing the SETANT pin. In the demo board, the SETANT voltage is 2.5V so the anticipation is 225ns.

The STSR30 works at 5V so it is necessary to obtain such voltage from the output. A low cost linear regulator (L78L05) is used. For the same reason the gate drive of the IC has a high value of 5V so a low threshold (logic level) MOSFET has to be used.

Another interesting feature of the STSR30 is its disable input. This is useful at low loads to turn off the IC and reduce its power consumption. In this condition, the Schottky diode D1 works like in a standard flyback. The information on the load level is obtained by averaging the voltage on the CK pin using R6, R15 and C4. The CK pin is low ($\sim 0V$) only when the current in the secondary winding is flowing (SR MOSFET on). Otherwise, the pin is pulled up at 5V. As the load decreases, the average voltage on CK pin becomes higher and higher. This voltage level is monitored by the last IC used, the TSM1015, a CV/CC controller that includes a voltage reference and two op-amps. The reference and the CV op-amp are used for the voltage control loop of the converter. The CC op-amp is not used for the current control loop but it acts as a comparator to sense the average voltage of the CK pin. At light loads, the CK voltage exceeds the threshold (V_{REF}) and the TSM1015 turns off the STSR30. By adding a little hysteresis (using R40), the DISABLE pin of the STSR30 is driven digitally with a good noise rejection.

The next two pictures show some waveforms during normal operation at full load. It is possible to see that the converter operates in CCM at 115 V_{RMS} and in DCM at 230 V_{RMS} .

Figure 2. $V_{IN} = 115V_{RMS} - 60Hz$

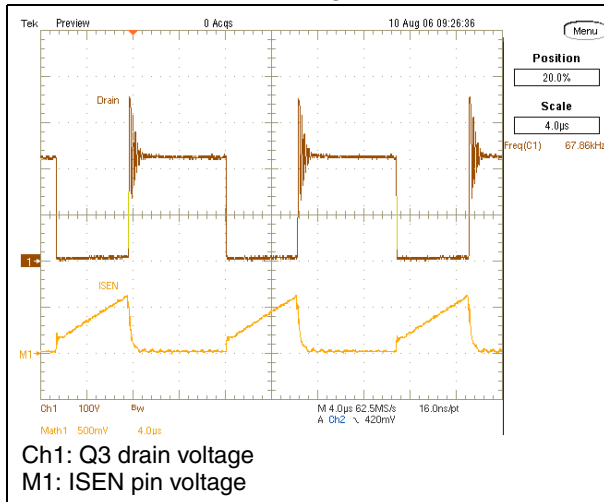

Figure 3. $V_{IN} = 230V_{RMS} - 50Hz$

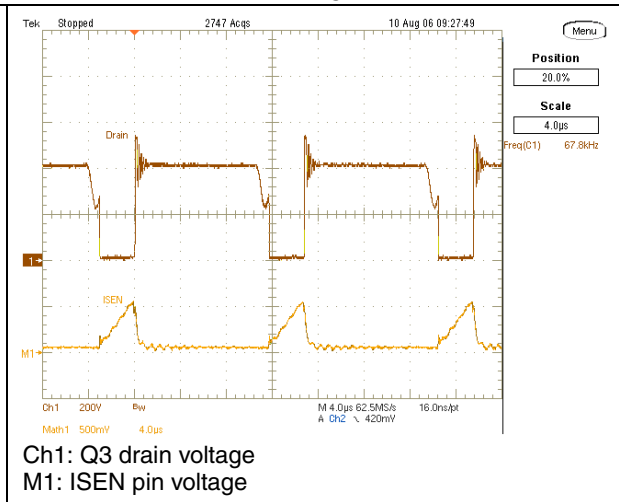

Figure 4 and Figure 5 show some of most important signals of the L6668 while operating at full load. The oscillator signal is stable and clean in all conditions.

Figure 4. $V_{IN} = 115V_{RMS} - 60Hz$

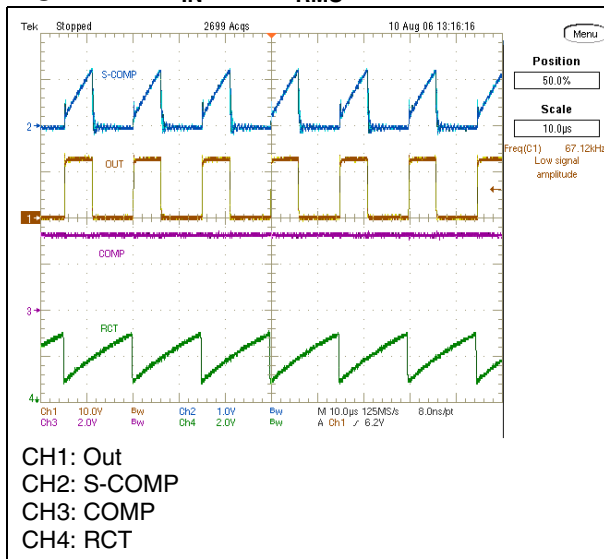
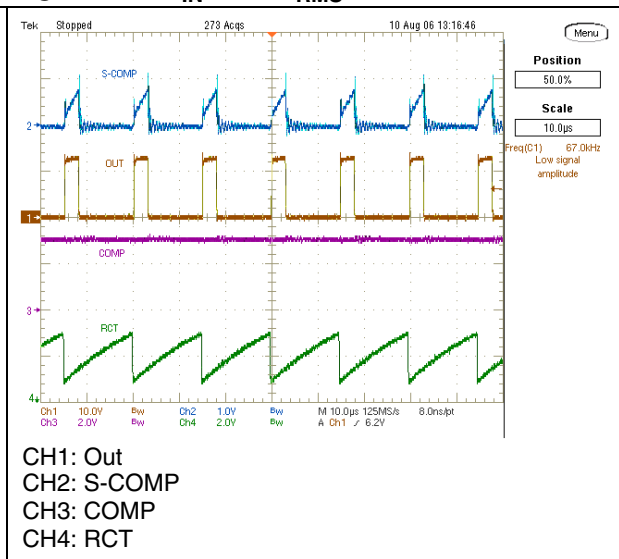

Figure 5. $V_{IN} = 230V_{RMS} - 50Hz$



On the secondary side, in CCM operation (full load with $V_{IN} = 115V_{AC}$), the gate drive of the STSR30 is synchronized with the CK pin (copy of SR MOSFET drain voltage clamped at 5V) as shown in Figure 6.

In Figure 7, the turn-off detail is zoomed and it is possible to see the anticipation amount (225ns) and the jitter due to the digital counter inside the IC. In fact, most times the anticipation has its typical value but sometimes the counter vary its value of ± 1 cycle (approximately $\pm 70ns$ using the 14-MHz internal oscillator). In any case, cross-conduction is always avoided.

Figure 6. $V_{IN} = 115V_{AC}$ - CCM

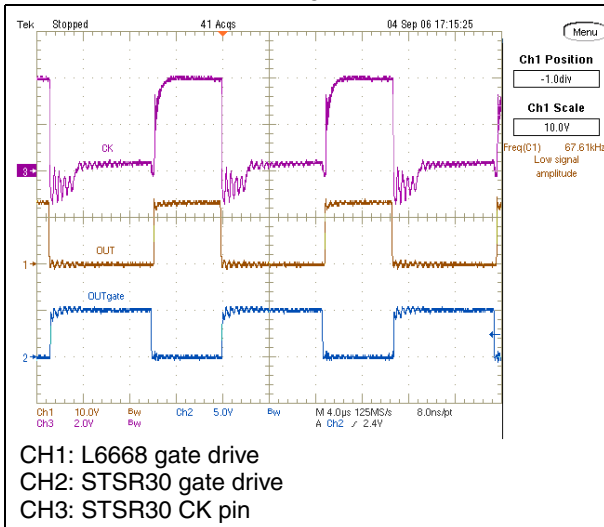
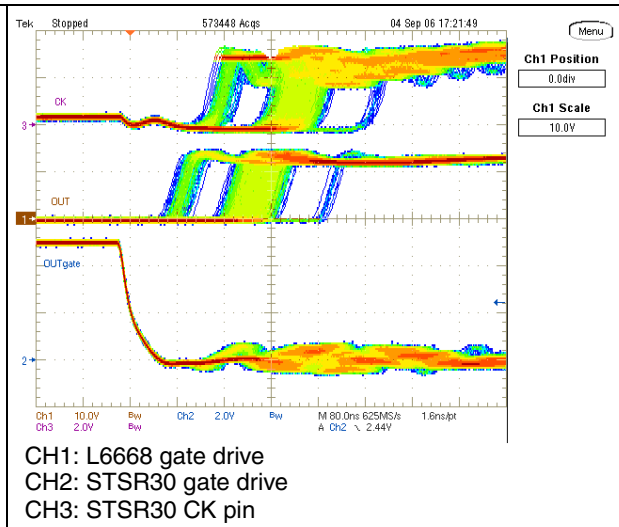

Figure 7. CCM - Anticipation detail



In DCM operation, the gate-drive turn-on is still triggered by the falling edge of the CK pin voltage, while turn-off is determined by the INHIBIT pin voltage crossing the -25mV internal threshold. [Figure 8](#) and [Figure 9](#) show this mechanism at full load and $V_{IN} = 230V_{AC}$ conditions.

Figure 8. $V_{IN} = 230V_{AC}$ - DCM

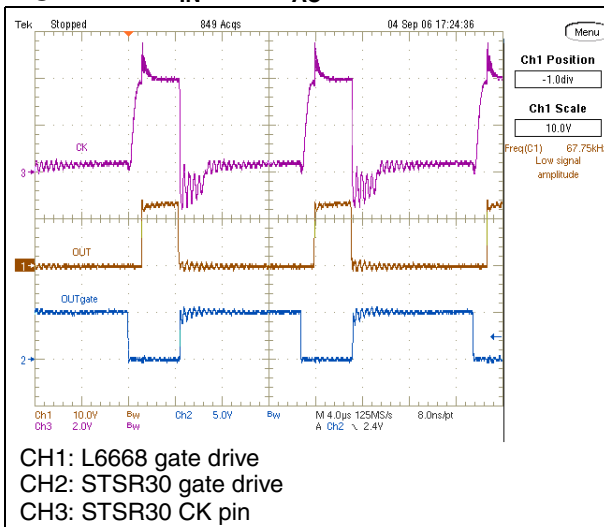
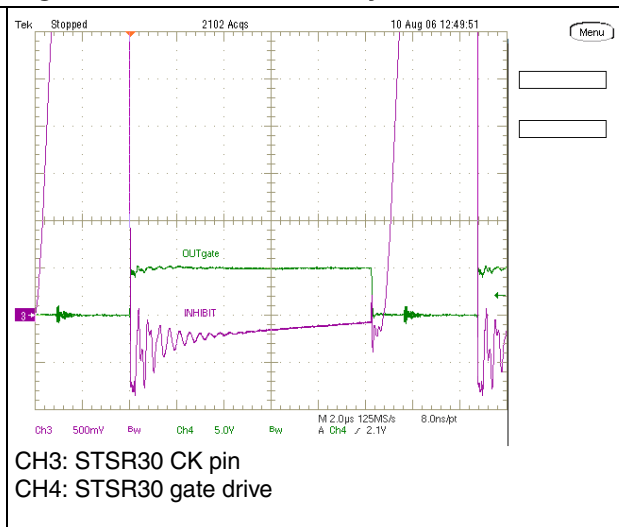

Figure 9. DCM - INHIBIT synchronization



2 Electrical performance

Table 1 shows the output voltage values at different input voltage and load amount conditions. Thanks to the good regulation, the maximum deviation is only about 10mV.

Table 1. Line and load regulation

$V_{OUT}[V]$		Input voltage [V_{RMS}]			
Output load [A]		88	115	230	264
	0	11.97	11.97	11.97	11.97
	1	11.97	11.97	11.97	11.98
	3	11.98	11.98	11.98	11.98
	5	11.98	11.98	11.98	11.98

In the next tables there are efficiency measurements taken at the two nominal voltages.

Table 2. Efficiency at 115V_{RMS}

Load [A]	P_{IN} [W]	I_{IN} [A]	P_{OUT} [W]	Eff [%]
1.00	13.82	0.247	11.96	86.54
1.25	17.25	0.299	14.96	86.72
2.00	27.3	0.453	23.95	87.73
2.50	34.04	0.553	29.94	87.96
3.00	40.77	0.650	35.99	88.28
3.75	51.57	0.801	44.81	86.89
4.00	55.08	0.851	47.89	86.95
5.00	69.27	1.043	59.88	86.44

Table 3. Efficiency at 230V_{RMS}

Load [A]	P_{IN} [W]	I_{IN} [A]	P_{OUT} [W]	Eff [%]
1.00	13.95	0.156	11.95	85.66
1.25	17.41	0.188	14.95	85.87
2.00	27.60	0.283	23.94	86.74
2.50	34.35	0.342	29.93	87.13
3.00	40.45	0.398	35.99	88.97
3.75	50.18	0.479	44.81	89.30
4.00	54.03	0.515	47.89	88.63
5.00	67.05	0.625	59.93	89.38

Table 4 shows the no-load consumption. The adapter has very good values (less than 200mW @ 230V_{AC}) thanks to the Burst mode operation and the high voltage startup of the L6668 and to the Disable mode of the STSR30.

Table 4. No load consumption

Value	88V _{AC}	115V _{AC}	230V _{AC}	264V _{AC}
Pin [W]	0.126	0.133	0.178	0.205
Vcc [V]	9.70	9.72	9.75	9.74

In Figure 10, the most important waveform are taken during Burst mode with no load.

Figure 10. Burst mode operation at 230V_{AC} and no load

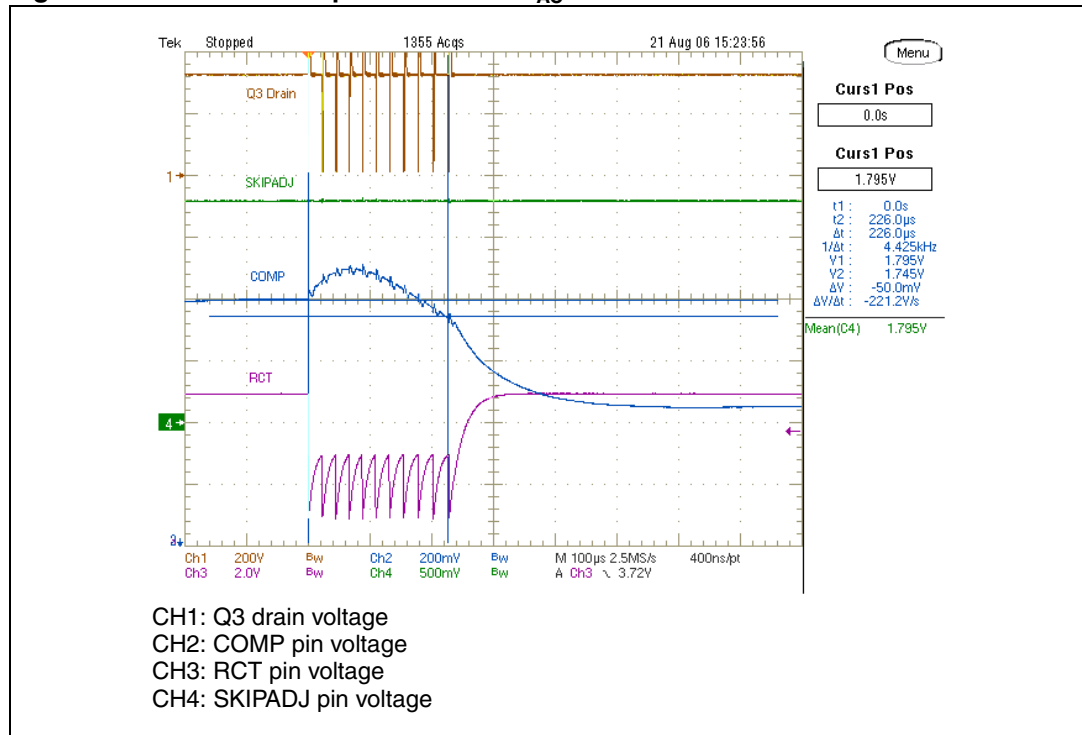

For the same reasons as in no load condition, the adapter has good consumption values also with 0.5W output power as shown in Table 5 for different input voltage values.

Table 5. Power consumption with 0.5W output

Value	88V _{AC}	115V _{AC}	230V _{AC}	264V _{AC}
Pin [W]	0.735	0.747	0.830	0.880

It is interesting to compare the demo board results with the targets set by the most important international energy saving programs. The results are shown in Table 6 (mandatory requirements) and Table 7 (voluntary requirements). Both tables take into account the worst nominal input voltage condition when measuring the no load consumption and efficiency values. This application is already compliant with all future (from 1 January 2008) energy programs.

Table 6. Mandatory energy saving requirements (from 1 January 2008)

Energy program	Pin no load	Measure	Efficiency	Measure	Compliant
California Energy Commission (CEC)	< 0.5 W	0.178 W (@230V _{AC})	> 85%	87% ⁽¹⁾ (@115V _{AC})	Yes
Australian	< 0.5 W		> 85%	87% ⁽¹⁾ (@115V _{AC})	Yes
China	< 0.75 W		> 82%	86.44% (@115V _{AC})	Yes

Table 7. Voluntary energy saving requirements (from 1 January 2008)

Energy program	Pin no load	Measure	Efficiency	Measure	Compliant
Energy Star	< 0.5 W	0.178 W (@230V _{AC})	> 84%	87% ⁽¹⁾ (@115V _{AC})	Yes
COC (Code Of Conduct) European Union	< 0.3 W		> 84%	86.44% (@115V _{AC})	Yes
China	< 0.75 W		> 85%	86.44% (@115V _{AC})	Yes

1. Efficiency measured at 25%, 50%, 75% and 100% of rated load and then averaged

Another important measurement is the efficiency improvement given by the synchronous rectification with respect to a standard (diode rectification) flyback. The test was performed using a STPS8H100 Schottky diode instead of the SR MOSFET. The results are shown in [Table 8](#). In a load range from 20% to 100% of the rated load, the average efficiency rise is 3.52% at 115V_{AC} and 3.75% at 230V_{AC}.

Table 8. Comparison between standard and SR flyback

Value	V _{IN} = 115V _{RMS}			V _{IN} = 230V _{RMS}		
	Eff _{SR}	Eff _{diode}	Var	Eff _{SR}	Eff _{diode}	Var
Load [A]						
1	86.54%	83.30%	+3.24%	85.66%	82.26%	+3.40%
2	87.73%	83.98%	+3.75%	86.74%	83.62%	+3.12%
3	88.28%	84.05%	+4.23%	88.97%	84.80%	+4.17%
4	86.95%	83.65%	+3.30%	88.63%	84.98%	+3.65%
5	86.44%	83.34%	+3.10%	89.38%	84.97%	+4.41%
	Average var @ 115V _{AC}		+3.52%	Average var @ 230V _{AC}		+3.75%

3 Functional check

3.1 Start-up behavior at full load

Figure 11 and Figure 12 show the start-up phase at full output load at minimum and maximum mains voltages. The rising time is nearly constant over all input voltage range. The output voltage reaches its regulated value without any overshoot.

The soft-start function is integrated in the L6668 controller and can be programmed by changing the value of C10.

Figure 11. Start-up at 88V_{AC} - 60Hz

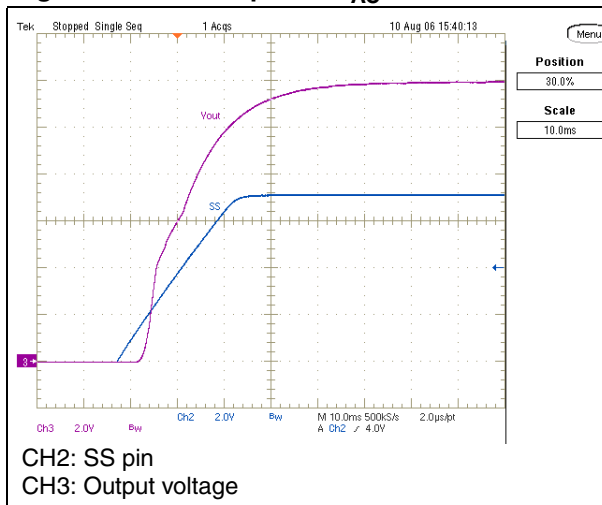
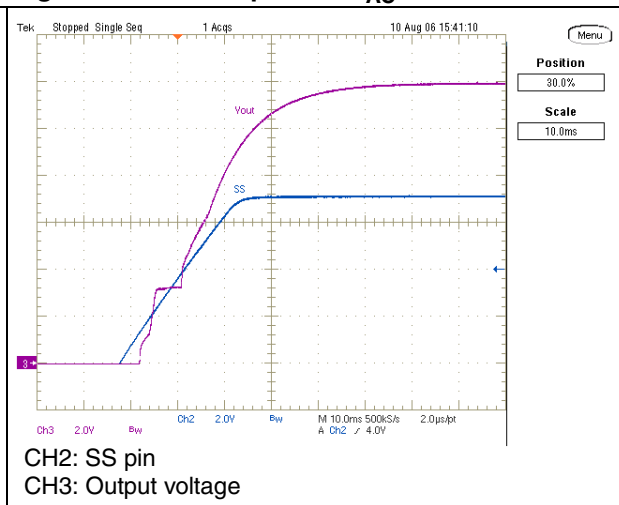

Figure 12. Start-up at 264V_{AC} - 50Hz



3.2 Wake-up time

The wake-up time is the time needed for the output voltage to reach its nominal value from the moment the adapter is plugged-in. Thanks to the internal high voltage start-up current generator of the L6668, the wake-up time of this demo board is quite fast (approx. 900ms) and, above all, independent of the mains voltage value.

When the IC starts, the generator is turned off, saving power in every working condition.

Figure 13. Wake-up at 115V_{AC} - 60Hz

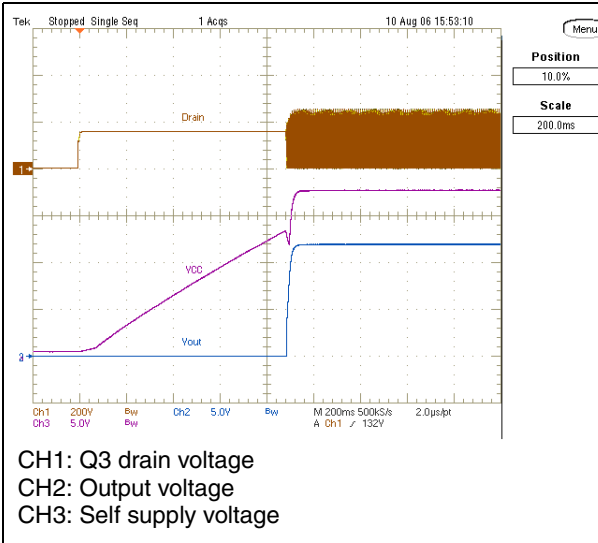
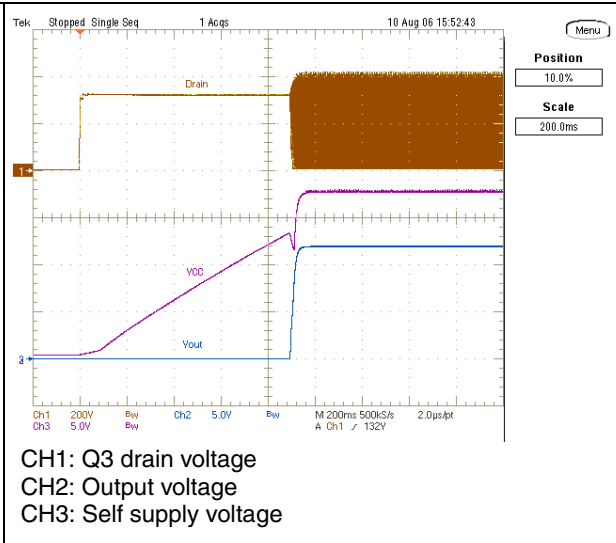

Figure 14. Wake-up at 230V_{AC} - 50Hz



3.3 Power-down

Unplugging the adapter from the mains, the self supply and output voltages have clean transition without restart trials or glitches. *Figure 15* and *Figure 16* show the power-down waveforms at full load. It is possible to measure the hold-up time that, in the worst case (115V_{AC}), is approximately 16ms.

Figure 15. Power-down at 115V_{AC} - 60Hz

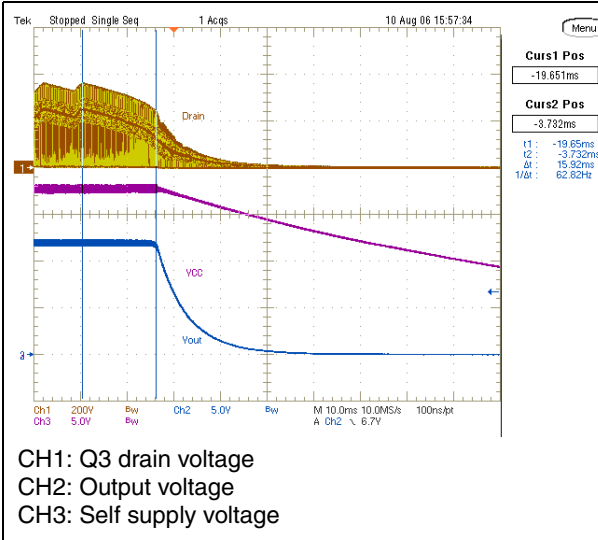
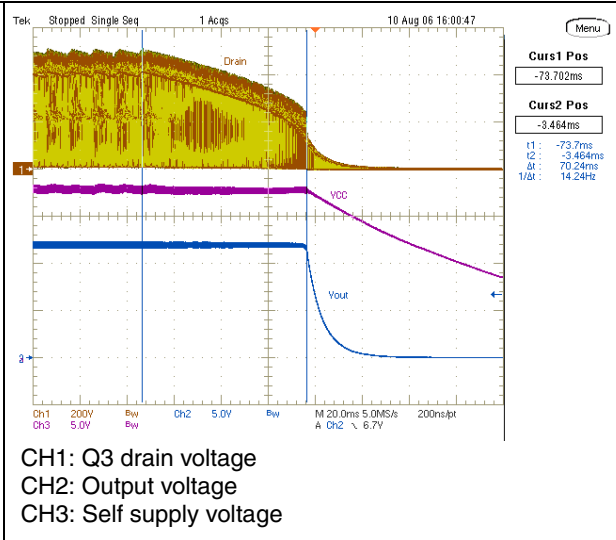

Figure 16. Power-down at 230V_{AC} - 50Hz



3.4 Short-circuit tests

The demo board has been tested with a short circuit directly on the output connector. During this fault condition, the circuit works in Hiccup mode thanks to the lack of self supply. Once the short-circuit is removed, the converter restarts working normally. The high voltage start-up generator of the L6668 ensures having constant on-off periods. The average output current during the short-circuit is well below the nominal value (approx. 0.8A).

Figure 17. Short circuit at 88V_{AC} - 60Hz

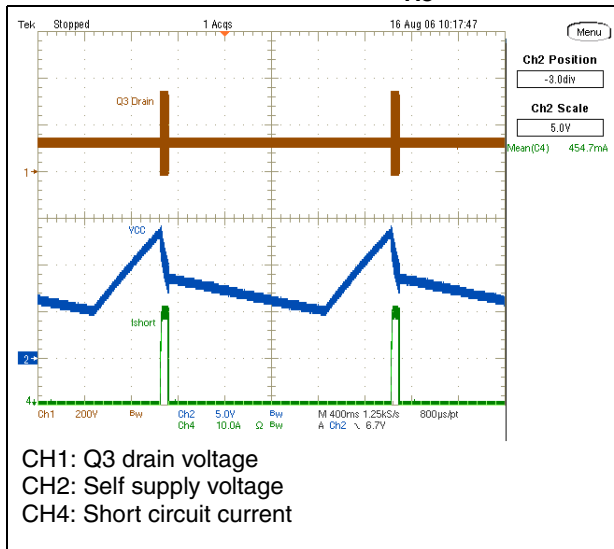
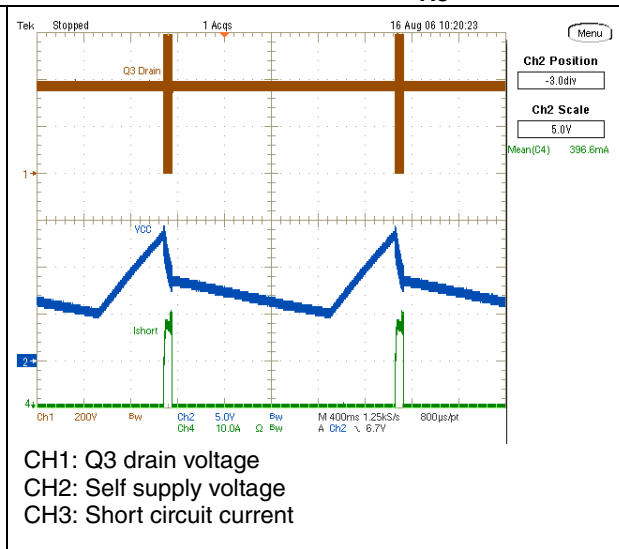

Figure 18. Short circuit at 264V_{AC} - 50Hz



3.5 Overvoltage protection

The DIS pin of the L6668 is dedicated to a latched protection of the circuit. In this application, it is used to provide overvoltage protection using components D11, R19, R28 and C13 connected to the auxiliary winding of the transformer. This network provides a mean rectified value cycle by cycle of the auxiliary voltage that tracks the output voltage. In the following figures, a feedback failure is simulated (open loop) and the most interesting waveforms are shown. As explained, this protection is latched and it is necessary to recycle the input power to restart the circuit.

Figure 19 and Figure 20 show the OVP protection intervention while the converter is operating at full load. In the whole input range during fault condition, V_{OUT} reaches 14V and V_{CC} reaches 20V.

Figure 19. OVP at 115V_{AC} - full load

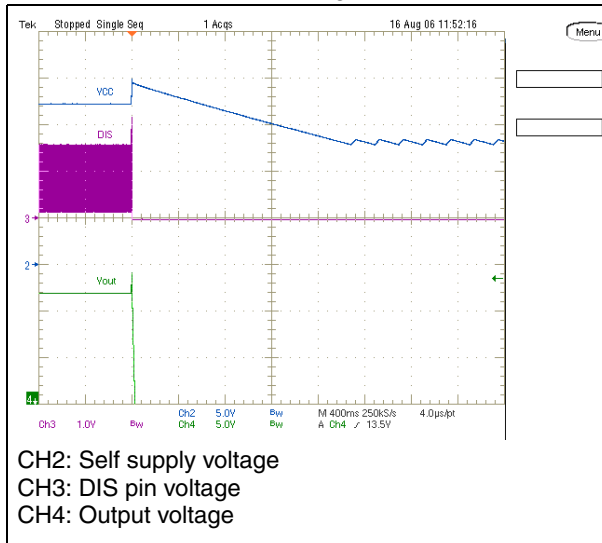
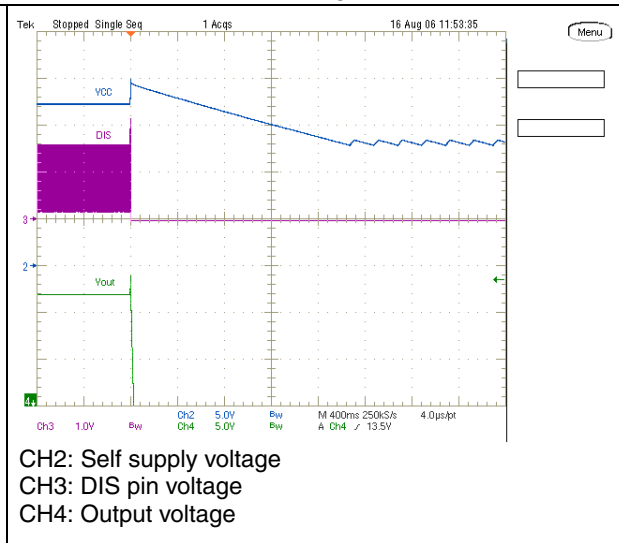

Figure 20. OVP at 230V_{AC} - full load



Also during no-load operations (*Figure 21* and *Figure 22*), the OVP protection stops the converter at similar V_{OUT} voltage levels (14.2V). The V_{CC} voltage value reaches lower values (16.5V) in respect to full load condition since it starts from approximately 10V.

Figure 21. OVP at 115V_{AC} - no load

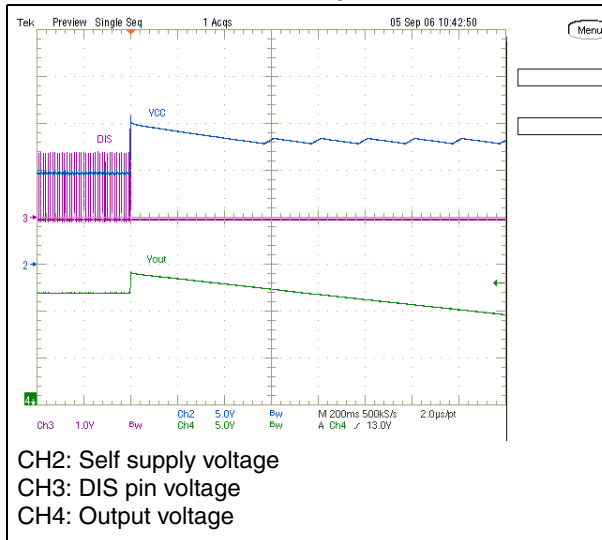
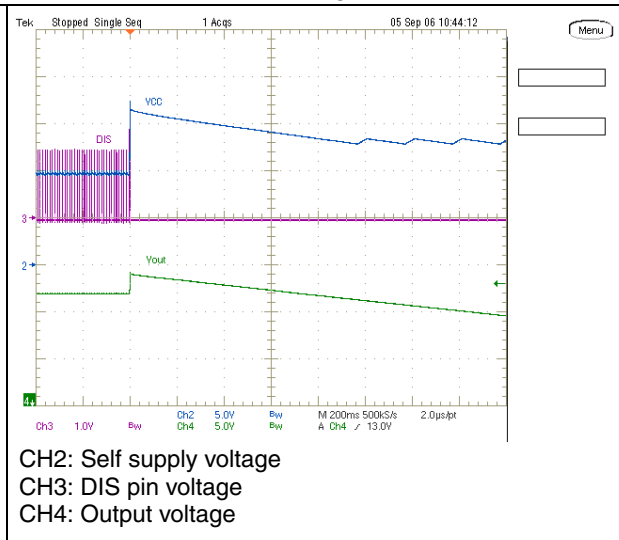

Figure 22. OVP at 230V_{AC} - no load



4 Conducted noise measurements (pre-compliance test)

The next two figures show the conducted noise measurements performed at the two nominal voltages with peak detection and considering only the worst phase. The measurements have a good margin with respect to the limits (stated in EN55022 Class-B specifications).

Figure 23. CE peak measure at 115V_{AC} and full load

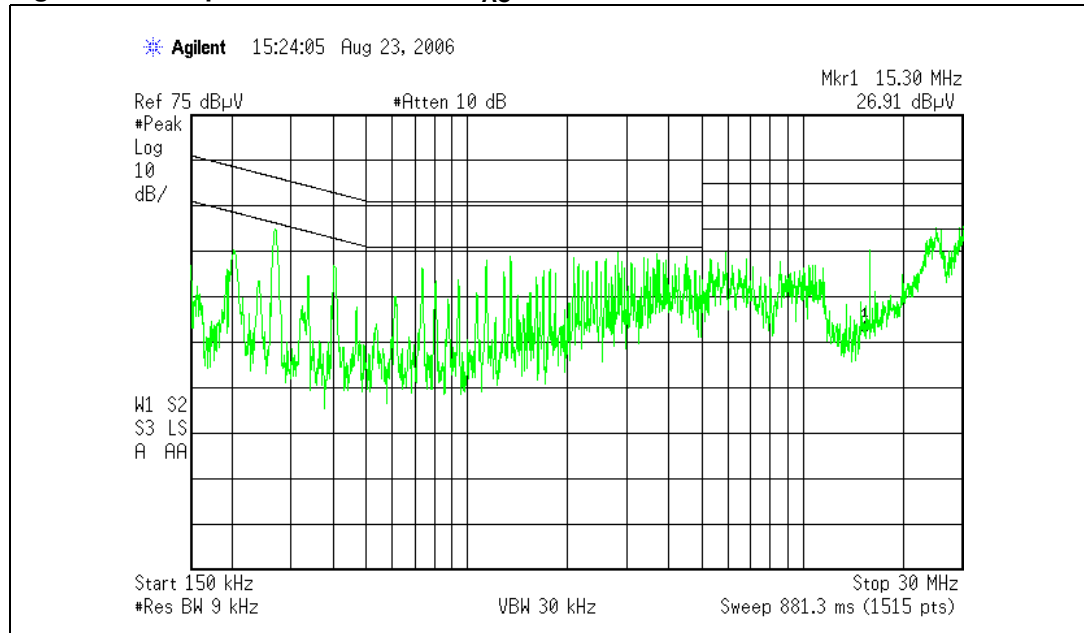
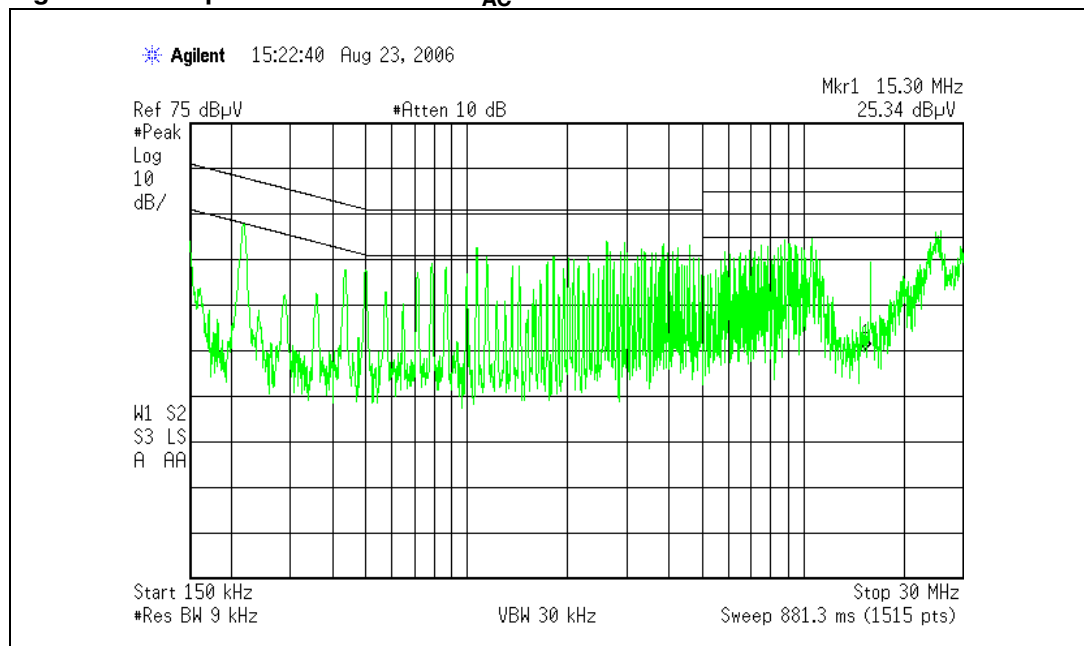

Figure 24. CE peak measure at 230V_{AC} and full load



5 Thermal measurements

A thermal analysis of the board was performed using an IR camera. The results are shown in [Figure 25](#) and [Figure 26](#) for 115V_{AC} and 230V_{AC} mains input. Both images refer to full load condition.

- T_{AMB} = 28°C for both figures
- Emissivity = 0.9 for all points

Figure 25. V_{IN} = 115V_{AC} - full load

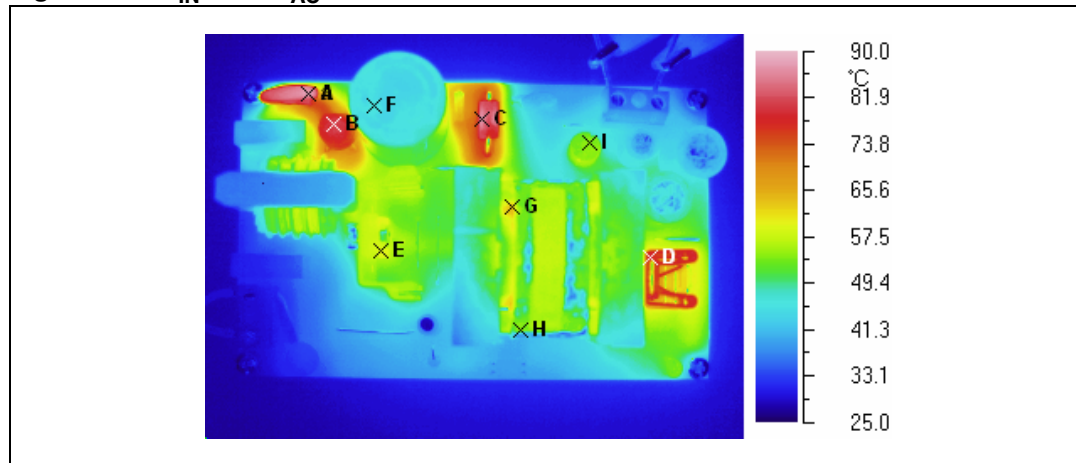

Table 9. Key components temperature at 115V_{AC} - full load

Point	Temp [°C]	Ref
A	88.2	NTC1
B	81.6	D7 (bridge)
C	87.8	D8 (clamp)
D	80.3	Q1 (SR MOS)
E	60.0	Q3
F	46.1	C8
G	64.2	T1 (windings)
H	55.1	T1 (ferrite)
I	54.7	L2

Figure 26. $V_{IN} = 230V_{AC}$ - full load

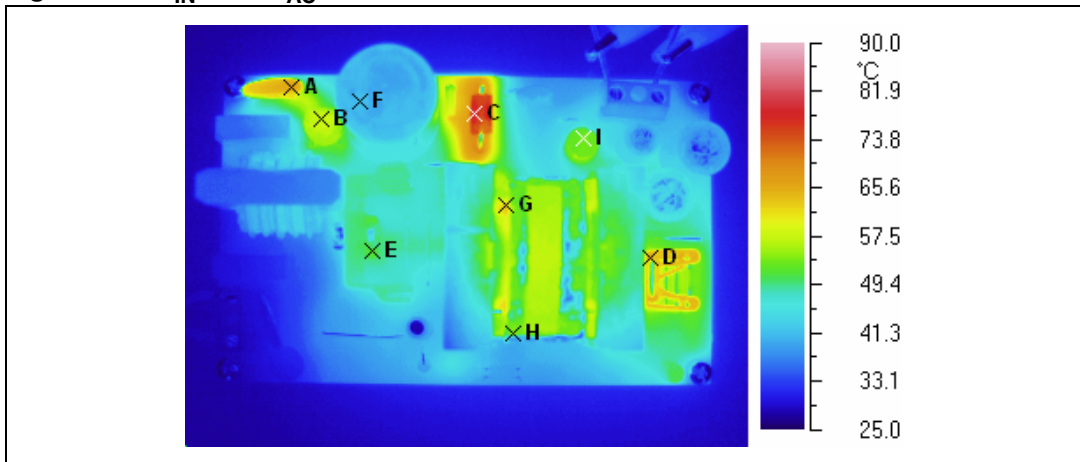

Table 10. Key components temperature at $230V_{AC}$ - full load

Point	Temp [°C]	Ref
A	66.2	NTC1
B	58.3	D7 (bridge)
C	80.0	D8 (clamp)
D	65.6	Q1 (SR MOS)
E	51.8	Q3
F	41.6	C8
G	63.4	T1 (windings)
H	54.4	T1 (ferrite)
I	53.8	L2

6 Bill of materials

[Table 11](#) lists the parts of the demo board.

Table 11. Part list

Ref	Part Value	Description	Manufacturer
C1	1000uF - 25V	Aluminium ELCAP 25ZL1000M12.5x20 - 105°C	Rubycon
C2	100nF - 50V	CERCAP X7R - General purpose	AVX
C3	100nF - 50V	CERCAP X7R - General purpose	AVX
C4	4.7nF - 50V	CERCAP X7R - General purpose	AVX
C5	1nF - 250V	Polyester CAP R82IC3100DQ02J	Arcotronics
C6	47uF - 25V	Aluminium ELCAP - YXF series - 105°C	Rubycon
C7	470nF - 16V	CERCAP X7R - General purpose	AVX
C8	100uF - 400V	Aluminium ELCAP TS-UP series - ECEC2GP101BB - 85°C	Panasonic
C9	1nF - 50V	CERCAP X7R - General purpose	AVX
C10	68nF - 50V	CERCAP X7R - General purpose	AVX
C11	1nF - 50V	CERCAP NP0 - General purpose - 1%	AVX
C12	100nF - 50V	CERCAP X7R - General purpose	AVX
C13	470pF - 50V	CERCAP NP0 - General purpose	AVX
C14	100nF - 275Vac	X2 film CAP - R46KI 3100xx M1 M	Arcotronics
C15	100nF - 275Vac	X2 film CAP - R46KI 3100xx M1 M	Arcotronics
C16	100nF - 50V	CERCAP X7R - General purpose	AVX
C17	2.2nF - 50V	CERCAP X7R - General purpose	AVX
C18	2.2nF - 250Vac	Y1 safety CAP - DE1E3KX222M	Murata
C19	1000uF - 25V	Aluminium ELCAP 25ZL1000M12.5x20 - 105°C	Rubycon
C20	220pF - 50V	CERCAP NP0 - General purpose	AVX
C21	100uF - 35V	Aluminium ELCAP - YXF series - 105°C	Rubycon
C22	470nF - 16V	CERCAP X7R - General purpose	AVX
C23	220pF - 50V	CERCAP NP0 - General purpose	AVX
C24	220pF - 50V	CERCAP NP0 - General purpose	AVX
C25	100nF - 50V	CERCAP X7R - General purpose	AVX
C26	N.M.	CERCAP X7R - General purpose	---
C27	100pF - 50V	CERCAP NP0 - General purpose	AVX
C28	1nF - 50V	CERCAP X7R - General purpose	AVX
C29	100nF - 50V	CERCAP X7R - General purpose	AVX
D1	STPS2H100	Power Schottky rectifier	STMicroelectronics

Table 11. Part list (continued)

Ref	Part Value	Description	Manufacturer
D2	LL4148	Fast switching diode	Vishay
D3	LL4148	Fast switching diode	Vishay
D4	LL4148	Fast switching diode	Vishay
D5	STTH1L06U	Ultrafast high voltage rectifier	STMicroelectronics
D6	BAV103	Fast switching diode	Vishay
D7	W06G	Single phase bridge rectifier	Vishay
D8	1.5KE200A	Transil	STMicroelectronics
D9	1N4148WS	Fast switching diode	Vishay
D10	LL4148	Fast switching diode	Vishay
D11	BAV103	Fast switching diode	Vishay
F1	T2A	PCB FUSE 2A time delay TR5 - 372 1200	Wickmann
J1	MKDS 1,5/3-5.08	PCB term. block, screw conn., pitch 5.08	Phoenix Contact
J2	MKDS 1,5/3-5.08	PCB term. block, screw conn., pitch 5.08	Phoenix Contact
L1	2x27mH	Common mode choke coil - B82734-R2172-B30	EPCOS
L2	2u2	Power inductor - RFB0807-2R2L	Coilcraft
L3	100uH	RF inductor - B78108S1104J000	EPCOS
NTC1	5R - S237	NTC resistor - B57237S0509M000	EPCOS
Q1	STP75NF75L	N-channel Power MOSFET	STMicroelectronics
Q1	FK 242 SA 220 O	Heatsink	Fischer
Q2	BC807-25	Small signal PNP transistor	Vishay
Q3	STP9NK70ZFP	N-channel Power MOSFET	STMicroelectronics
Q3	593002B03400	Heatsink	Aavid
RV1	S14K275	Varistor - B72214S0271K101	EPCOS
R1	1k	SMD standard film resistor - 0805 - 5% - 250ppm/°C	Vishay
R2	1k	SMD standard film resistor - 0805 - 5% - 250ppm/°C	Vishay
R3	22	SMD standard film resistor - 0805 - 5% - 250ppm/°C	Vishay
R4	33k	SMD standard film resistor - 1206 - 5% - 250ppm/°C	Vishay
R5	33k	SMD standard film resistor - 0805 - 5% - 250ppm/°C	Vishay
R6	100k	SMD standard film resistor - 0805 - 1% - 100ppm/°C	Vishay
R8	33k	SMD standard film resistor - 0805 - 5% - 250ppm/°C	Vishay
R9	0.56	SMD standard film resistor - 1206 - 1% - 100ppm/°C	Vishay
R10	0.56	SMD standard film resistor - 1206 - 1% - 100ppm/°C	Vishay
R11	22	SMD standard film resistor - 0805 - 5% - 250ppm/°C	Vishay
R12	1k	SMD standard film resistor - 0805 - 5% - 250ppm/°C	Vishay
R13	N.M.	SMD standard film resistor - 0805	Vishay

Table 11. Part list (continued)

Ref	Part Value	Description	Manufacturer
R14	2.2k	SMD standard film resistor - 0805 - 1% - 100ppm/°C	Vishay
R15	68k	SMD standard film resistor - 1206 - 1% - 100ppm/°C	Vishay
R16	2.7Meg	SMD standard film resistor - 1206 - 1% - 100ppm/°C	Vishay
R17	2.7Meg	SMD standard film resistor - 1206 - 1% - 100ppm/°C	Vishay
R18	9.1k	SMD standard film resistor - 0805 - 1% - 100ppm/°C	Vishay
R19	33k	SMD standard film resistor - 0805 - 1% - 100ppm/°C	Vishay
R20	2.7k	SMD standard film resistor - 0805 - 5% - 250ppm/°C	Vishay
R21	20k	SMD standard film resistor - 0805 - 1% - 100ppm/°C	Vishay
R22	1.5k	SMD standard film resistor - 0805 - 1% - 100ppm/°C	Vishay
R23	N.M.	SMD standard film resistor - 0805	Vishay
R24	47k	SMD standard film resistor- 1206 - 1% - 100ppm/°C	Vishay
R25	15k	SMD standard film resistor - 1206 - 1% - 100ppm/°C	Vishay
R27	20k	SMD standard film resistor - 0805 - 1% - 100ppm/°C	Vishay
R26	82k	SMD standard film resistor - 0805 - 1% - 100ppm/°C	Vishay
R28	3.9k	SMD standard film resistor - 0805 - 1% - 100ppm/°C	Vishay
R29	10	SMD standard film resistor - 0805 - 5% - 250ppm/°C	Vishay
R32	0	SMD standard film resistor - 0805	Vishay
R33	9.1k	SMD standard film resistor - 0805 - 1% - 100ppm/°C	Vishay
R34	0	SMD standard film resistor - 1206	Vishay
R37	330k	SMD standard film resistor - 0805 - 1% - 100ppm/°C	Vishay
R38	33k	SMD standard film resistor - 1206 - 5% - 250ppm/°C	Vishay
R39	0	SMD standard film resistor - 1206	Vishay
R40	1Meg	SMD standard film resistor - 1206 - 1% - 100ppm/°C	Vishay
T1	See Spec	Power transformer	
U1	STSR30D	Synchronous rectifier smart driver	STMicroelectronics
U2	L78L05ACZ	Voltage regulator	STMicroelectronics
U3	L6668	Smart primary controller	STMicroelectronics
U4	TSM1015ID	Voltage and current controller	STMicroelectronics
U5	PC817X2J000F	Optocoupler	Sharp

7 PCB layout

Figure 27. Silk screen - top side

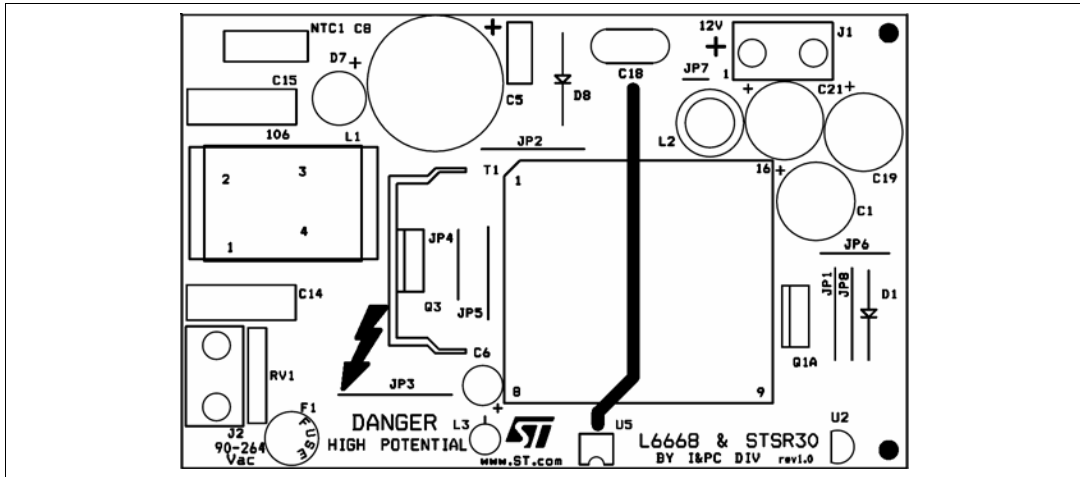

Figure 28. Silk screen - bottom side

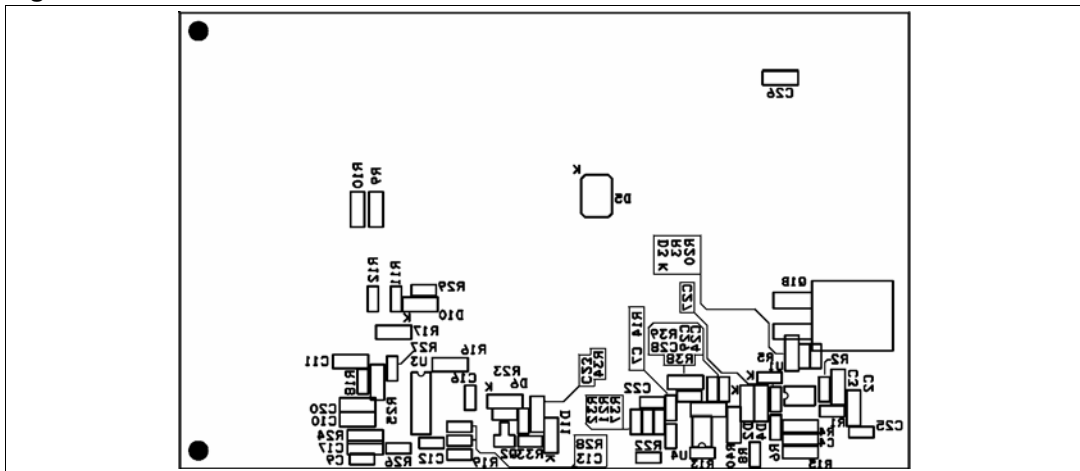
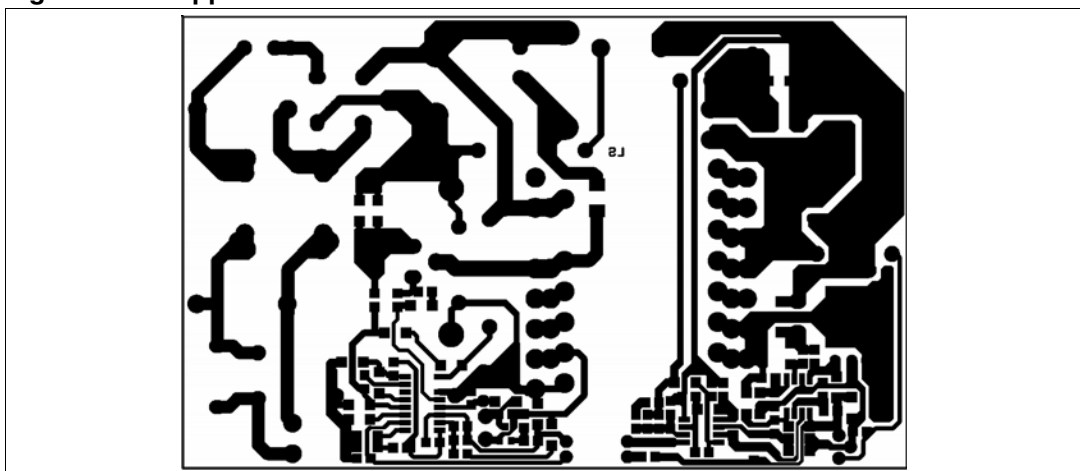

Figure 29. Copper tracks



8 Transformer specification

- Application type: Consumer, Home Appliance
- Transformer type: Open
- Winding type: Layer
- Coil former: Horizontal type, 7+7 pins
- Maximum temperature increase: 45° C
- Maximum operating ambient temperature: 60° C
- Mains insulation: according with EN60065

8.1 Electrical characteristics

- Converter topology: Flyback, CCM/DCM mode
- Core type: ETD34 - N87 or equivalent
- Typical operating frequency: 70 kHz
- Primary inductance: 530 $\mu\text{H} \pm 10\%$ @ 1 kHz - 0.25V (*Note 1*)
- Air Gap: 1.2mm on central leg (std. value)
- Leakage inductance: 9 μH (Maximum) @ 100 kHz - 0.25V (*Note 2*)
- Maximum peak primary current: 3.7 A_{pk}
- RMS primary current: 1.06 A_{RMS}

Note: 1 Measured between pins 1 and 3

2 Measured between pins 1 and 3 with secondary shorted

Figure 30. Transformer electrical diagram

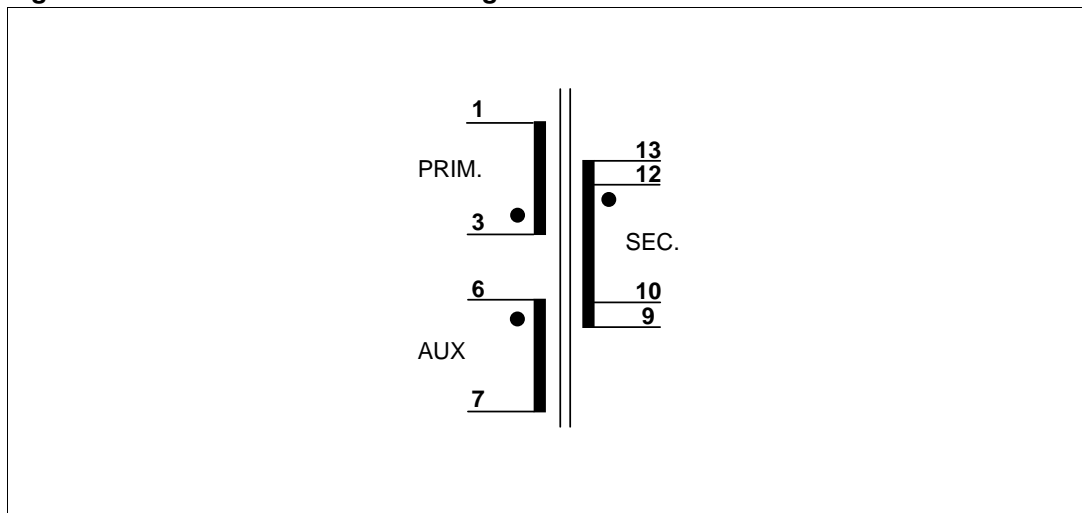
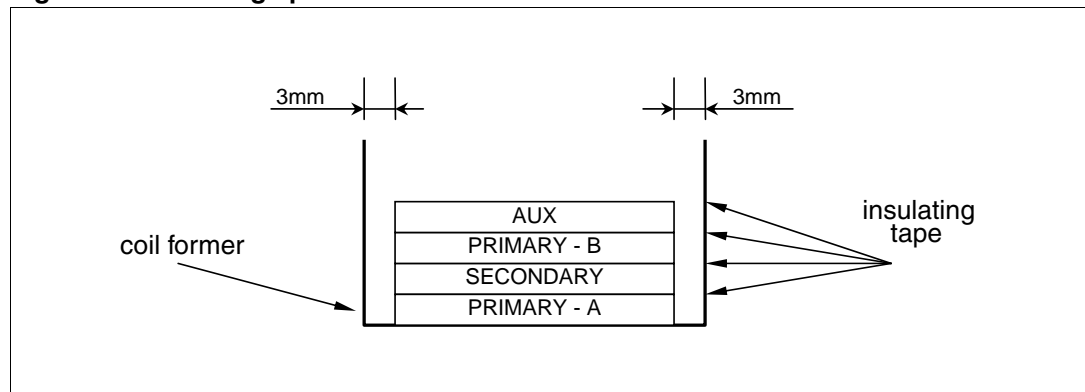

Table 12. Winding characteristics

Pins	Winding	RMS current	Number of turns	Wire type
3 – 2	PRIMARY - A	1.06 A _{RMS}	32	G2 – 2 x ϕ 0.45 mm
12, 13 – 9, 10	SECONDARY	7.4 A _{RMS}	8	G2 – 60 x ϕ 0.18 mm
2 – 1	PRIMARY - B	1.06 A _{RMS}	31	G2– 2 x ϕ 0.45 mm
6 – 7	AUX	0.05 A _{RMS}	12 Spaced	G2 – ϕ 0.25 mm

Figure 31. Windings position



Note: Primaries A and B are in series.

Note: Cover primary and auxiliary wire ends with silicon sleeve.

8.2 Mechanical aspect

- Maximum height from PCB: 35 mm
- Coil former type: horizontal, 7+7 pins (Pins #2 and #8 removed)
- Pins pitch: 5.08 mm
- Rows distance: 25.4 mm
- Pins #2 and #8 removed
- External copper shield: 12 mm width

9 Revision history

Table 13. Revision history

Date	Revision	Changes
26-Sept-2006	1	Initial release
23-Oct-2006	2	Minor text changes

Please Read Carefully:

Information in this document is provided solely in connection with ST products. STMicroelectronics NV and its subsidiaries ("ST") reserve the right to make changes, corrections, modifications or improvements, to this document, and the products and services described herein at any time, without notice.

All ST products are sold pursuant to ST's terms and conditions of sale.

Purchasers are solely responsible for the choice, selection and use of the ST products and services described herein, and ST assumes no liability whatsoever relating to the choice, selection or use of the ST products and services described herein.

No license, express or implied, by estoppel or otherwise, to any intellectual property rights is granted under this document. If any part of this document refers to any third party products or services it shall not be deemed a license grant by ST for the use of such third party products or services, or any intellectual property contained therein or considered as a warranty covering the use in any manner whatsoever of such third party products or services or any intellectual property contained therein.

UNLESS OTHERWISE SET FORTH IN ST'S TERMS AND CONDITIONS OF SALE ST DISCLAIMS ANY EXPRESS OR IMPLIED WARRANTY WITH RESPECT TO THE USE AND/OR SALE OF ST PRODUCTS INCLUDING WITHOUT LIMITATION IMPLIED WARRANTIES OF MERCHANTABILITY, FITNESS FOR A PARTICULAR PURPOSE (AND THEIR EQUIVALENTS UNDER THE LAWS OF ANY JURISDICTION), OR INFRINGEMENT OF ANY PATENT, COPYRIGHT OR OTHER INTELLECTUAL PROPERTY RIGHT.

UNLESS EXPRESSLY APPROVED IN WRITING BY AN AUTHORIZED ST REPRESENTATIVE, ST PRODUCTS ARE NOT RECOMMENDED, AUTHORIZED OR WARRANTED FOR USE IN MILITARY, AIR CRAFT, SPACE, LIFE SAVING, OR LIFE SUSTAINING APPLICATIONS, NOR IN PRODUCTS OR SYSTEMS WHERE FAILURE OR MALFUNCTION MAY RESULT IN PERSONAL INJURY, DEATH, OR SEVERE PROPERTY OR ENVIRONMENTAL DAMAGE. ST PRODUCTS WHICH ARE NOT SPECIFIED AS "AUTOMOTIVE GRADE" MAY ONLY BE USED IN AUTOMOTIVE APPLICATIONS AT USER'S OWN RISK.

Resale of ST products with provisions different from the statements and/or technical features set forth in this document shall immediately void any warranty granted by ST for the ST product or service described herein and shall not create or extend in any manner whatsoever, any liability of ST.

ST and the ST logo are trademarks or registered trademarks of ST in various countries.

Information in this document supersedes and replaces all information previously supplied.

The ST logo is a registered trademark of STMicroelectronics. All other names are the property of their respective owners.

© 2006 STMicroelectronics - All rights reserved

STMicroelectronics group of companies

Australia - Belgium - Brazil - Canada - China - Czech Republic - Finland - France - Germany - Hong Kong - India - Israel - Italy - Japan - Malaysia - Malta - Morocco - Singapore - Spain - Sweden - Switzerland - United Kingdom - United States of America

www.st.com